

MADE
IN
ITALY



MOTTURA **b** TECHNOLOGY®

Smart security solutions



safeguarding your security



MOBILE APP



PIN CODE



FINGERPRINT



BLUETOOTH



CLOUD



WIFI





































TRANSPONDER

Connected security, total control.

The bTECHNOLOGY platform is the result of over fifty years of Mottura's expertise in the design and production of high security locks and cylinders, combined with a constant focus on technological innovation.

The system includes a complete range of actuators (locks, knobs and relays) integrated with dedicated accessories, all designed to simplify everyday use and access management.

Through the bMOTTURA App, you can manage and control every access point directly from your smartphone, at any time and from anywhere.

 NOVA	Motorized lock	 
 BLOCK	Electromechanical lock	 
 MOTO	Motorized knob	 
 OPEN	Stand-alone device for dry contact	 
 DIGIT	BLE keypad	  
 TRACK	BLE fingerprint reader	  
 TAG	TAG transponder reader BLE	  
 KEY	Remote control BLE	 
 BRIDGE	Bridge for cloud connection	   
 MOTTURA	Access management via app	 

MOTTURA TECHNOLOGY[®]

The bTECHNOLOGY range represents Mottura's ongoing innovation in the field of motorised locks.

From the very first stages of the logo design, the aim was to highlight the core concept of this new product family: wireless transmission.

All devices operate in wireless mode, communicating with one another without cabling thanks to BLE (Bluetooth Low Energy) connectivity, which ensures efficiency, reliability and reduced energy consumption.

Security evolves, life becomes simpler.

Experience a new kind of freedom: with the Mottura bTECHNOLOGY range, you can control doors, gates and garage entrances directly from your smartphone.



Innovation is essential

Changing habits is never easy, but evolving is necessary. Mottura's smart range makes it easier to bring our security in line with the standards of the digital world, thanks to systems and interfaces that are simple to install, learn and use with the natural ease of everyday gestures.

The bTECHNOLOGY platform

The best technologies to ensure security and convenience: Bluetooth, Cloud and smartphone and Web Apps, numeric keypads, fingerprint readers, transponder cards and remote controls. There is no limit to the customisation possibilities for control and security systems.

The bMOTTURA App offers complete and secure management, with remote access, real time notifications, the ability to create personalised invitation codes and to set time slots to enable temporary access.



Discover the
bTECHNOLOGY range





bNOVA is a smart motorised lock for armoured doors, featuring Bluetooth Low Energy technology. It is controlled and managed via the bMOTTURA App and the bWEBTECHNOLOGY Web App.



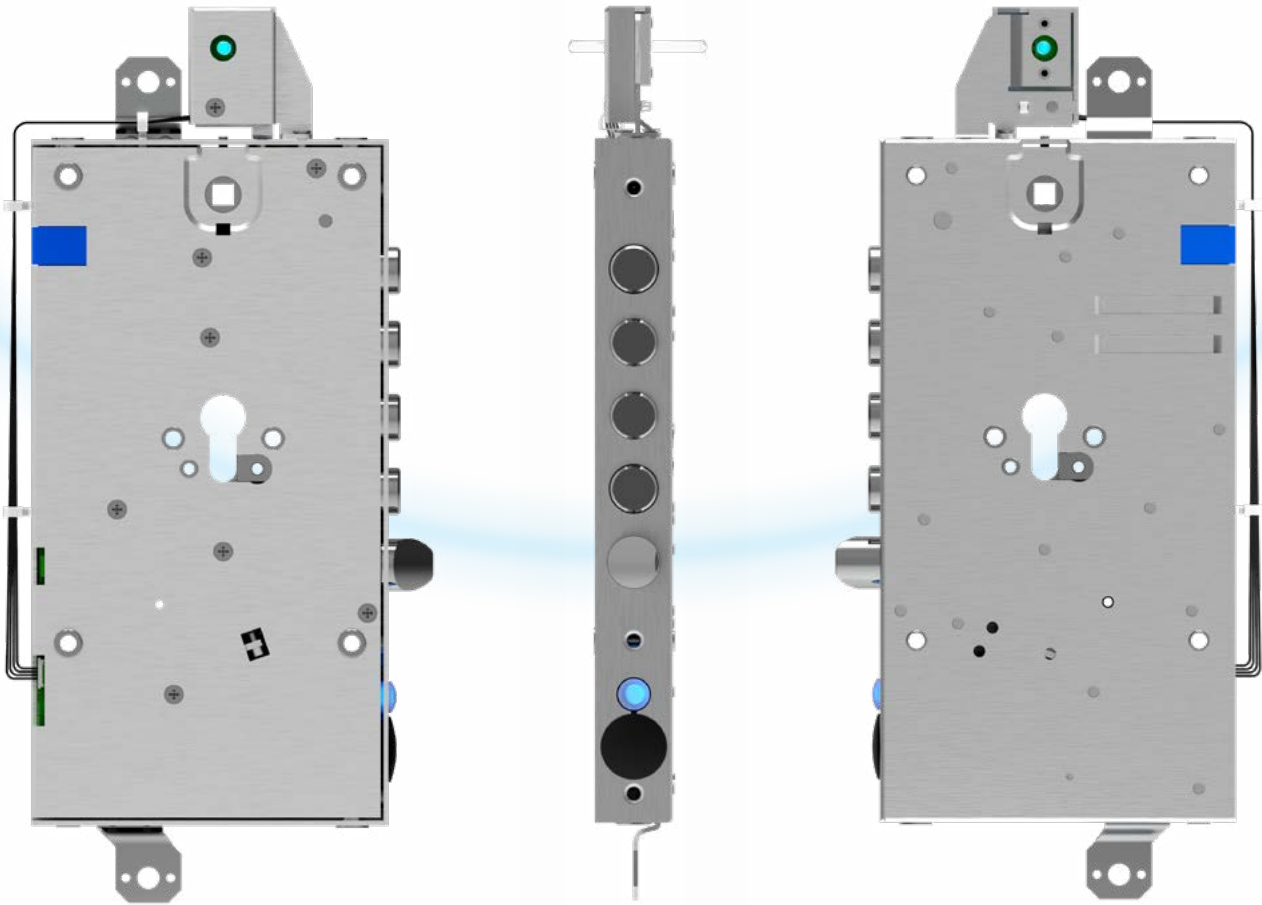

Specifications

- Motorized electronic lock
- Controlled and managed through the bMOTTURA App and the bWEBTECHNOLOGY platform
- Up to 100 supported devices (smartphones, peripherals, codes, etc.)
- Integrated access control (data log of last 1000 events and time control)
- Managed remotely via cloud with or without bBRIDGE
- Internal diagnostic system
- Integrated magnetic folding sensor
- BLE (Bluetooth Low Energy) vers.5 integrated
- Mains or battery power
- Led for signalling

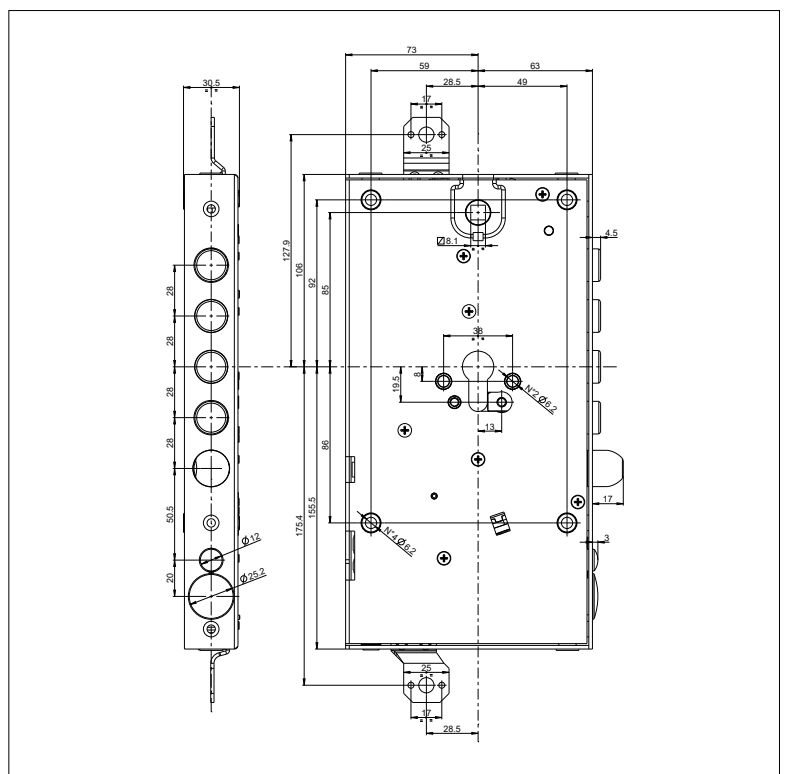

Compatible with Web App and smartphone

bBLOCK

bBLOCK is a smart mechatronic lock designed for European cylinders, available in both knob-knob and key-knob versions for armoured doors



bMOTO

bMOTO is a smart motorised knob which can be installed on all types of doors, provided they are equipped with a friction key-key or key-shank cylinder.

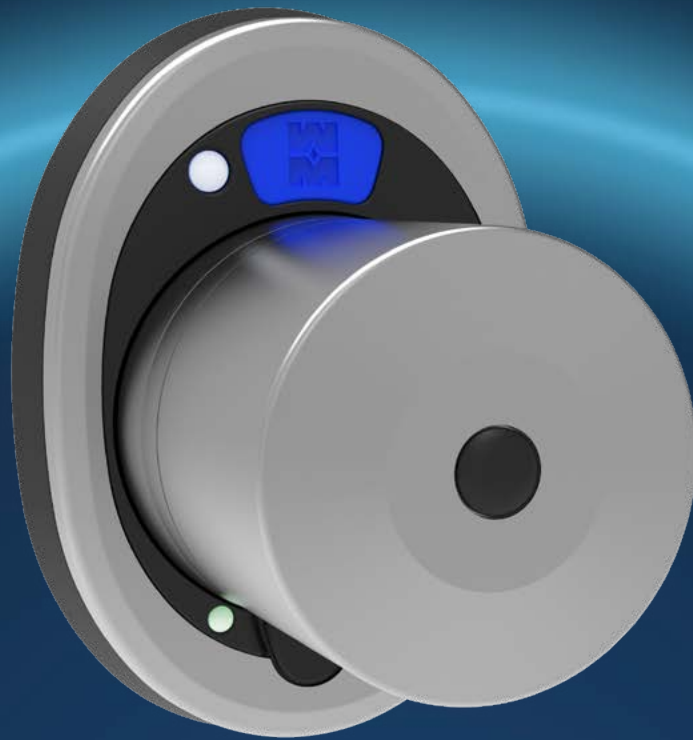



Specifications

- Motorized knob
- Quick fixing system
- Controlled and managed through the bMOTTURA App and the bWEBTECHNOLOGY platform
- Up to 100 devices supported (smartphones, peripherals, codes, etc.)
- Integrated access control (history storage of 1000 events and time control)
- Peripheral management from master smartphone via bMOTTURA App
- Managed remotely via cloud with or without bBRIDGE
- Rechargeable battery powered with special magnetic USB-C cable
- Internal diagnostic system
- Integrated automatic closing sensor without magnet
- For all types of Europrofile cylinder doors
- BLE (Bluetooth Low Energy) vers. 5 integrated
- Finishes: black, satin chrome
- Accessory available for opening with dry contact

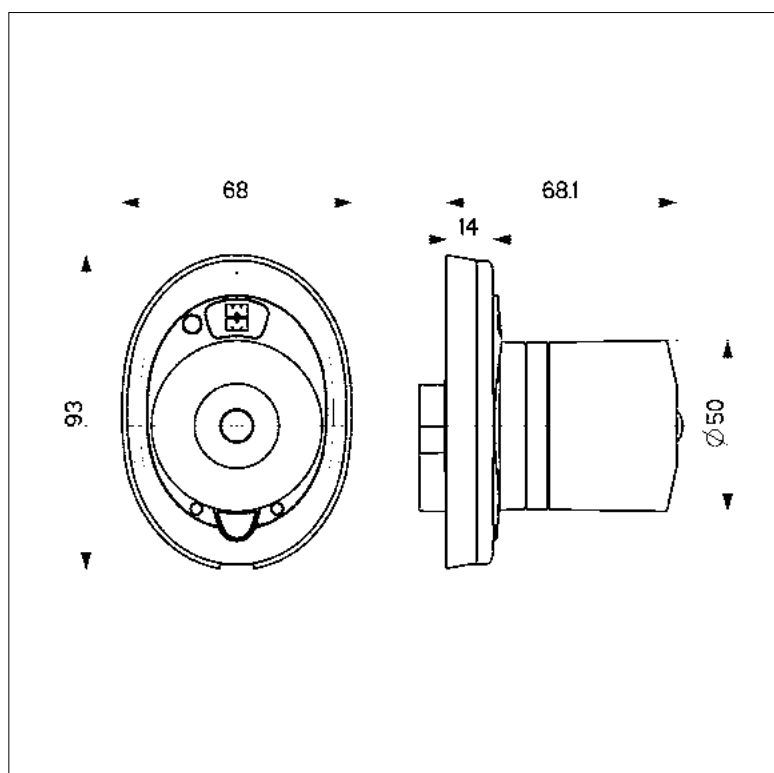

Compatible with Web App and smartphone

b OPEN

bOPEN is a smart relay with Bluetooth which connects via a clean contact to all electronic locks and electronic strikes.





Specifications

- Dry contact opening interface
- Controlled and managed through the bMOTTURA App and the bWEBTECHNOLOGY platform**
- Up to 100 supported devices (smartphones, peripherals, codes, etc.)
- Compatible with any type of lock with dry contact
- Integrated Access Control (data log with last 1000 events and time control)
- Managed in proximity via Bluetooth and remotely via cloud with the Mottura bBRIDGE
- 12V mains power or 9V batteries
- BLE (Bluetooth Low Energy) vers.5 integrated
- Ease of installation
- Fixing on surfaces by screws

** Function available with bBRIDGE device

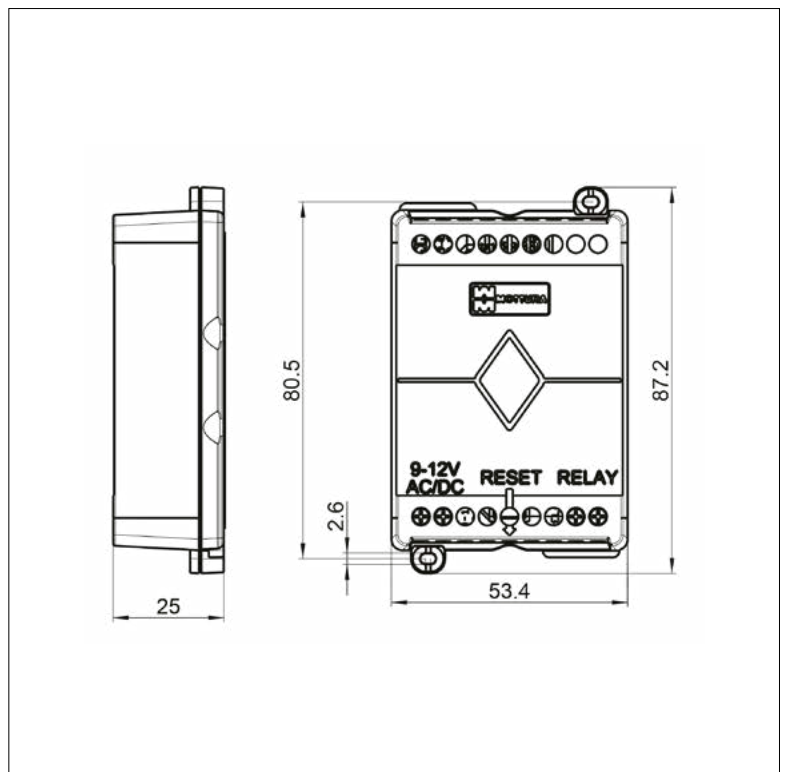

Compatible with Web App and smartphone

bDIGIT

bDIGIT is the Bluetooth numeric keypad, associated, controlled and managed by the bMOTTURA App and the bWEBTECHNOLOGY Web App.

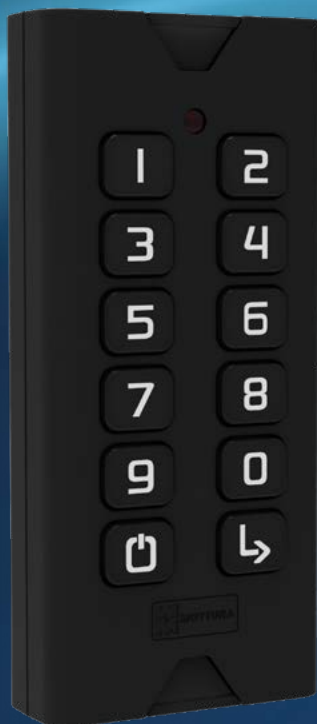

Version
surface mount



Version
built-in



Specifications

- Numeric keypad
- Controlled and managed through the bMOTTURA App and the bWEBTECHNOLOGY platform**
- Pairing from master smartphones
- Codes managed by master smartphones through bMOTTURA App manageable on time slots for access control system integrated to the lock
- Finishes: black, satin chrome
- Battery or mains power
- BLE (Bluetooth Low Energy) vers.5 integrated
- Available in version surface mount or built-in

** Function available with bBRIDGE device

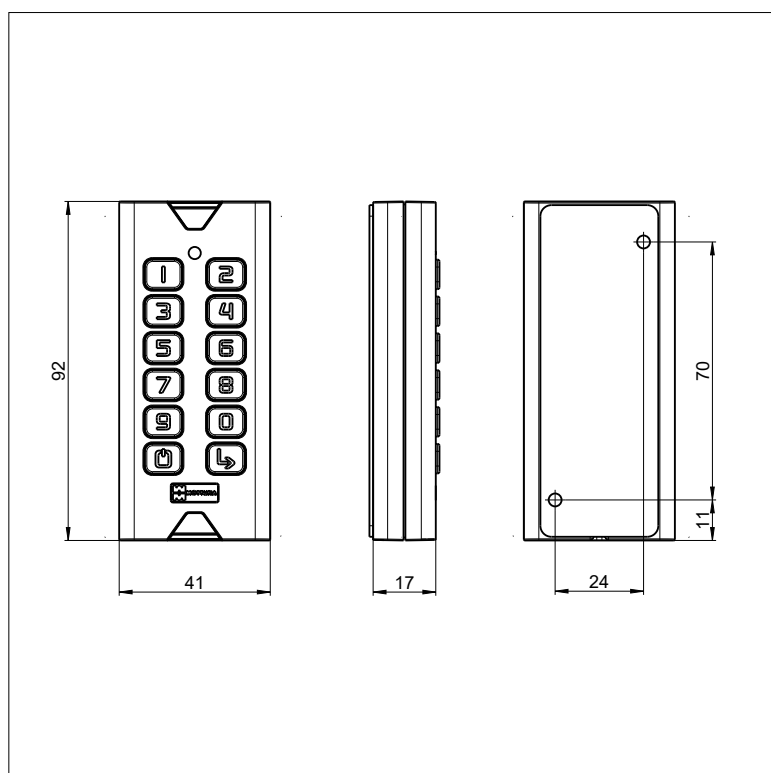

Compatible with Web App and smartphone

bTRACK

bTRACK is the Bluetooth biometric fingerprint reader, associated, controlled and managed by the bMOTTURA App and the bWEBTECHNOLOGY Web App.



Version
surface mount



Version
built-in

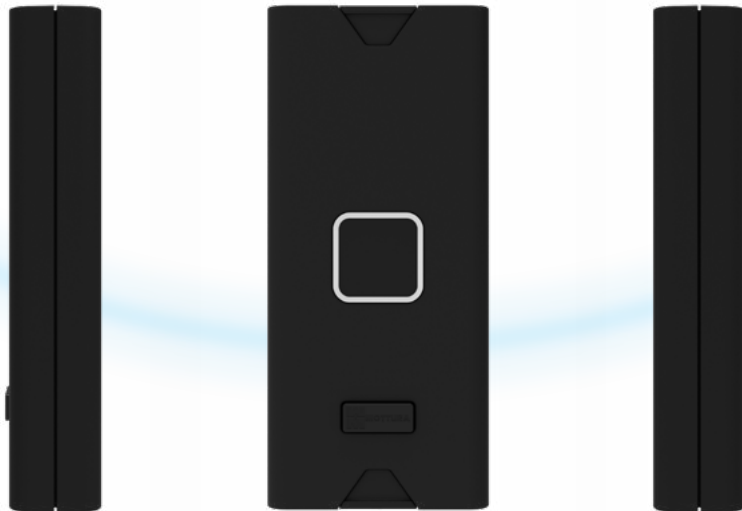

Specifications

- Biometric fingerprint reader
- Controlled and managed through the bMOTTURA App and the bWEBTECHNOLOGY platform**
- Pairing from master smartphones
- Fingerprint management (MAX 100) from master smartphone through bMOTTURA App manageable on time slots for access control system integrated to the lock
- Finishes: black, satin chrome
- Battery and mains power
- BLE (Bluetooth Low Energy) vers.5 integrated
- Stores up to 100 fingerprint
- Available in version surface mount or built-in

** Function available with bBRIDGE device

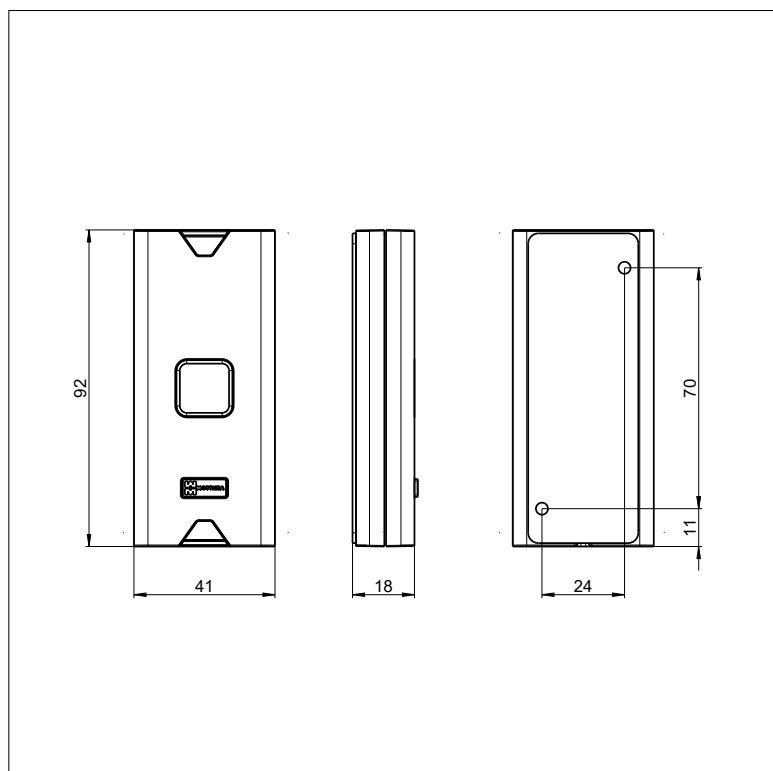

Compatible with Web App and smartphone



bTAG is a transponder reader controlled and managed by the bMOTTURA App and the bWEBTECHNOLOGY Web App.



Version
surface mount

Version
built-in



Specifications

- Transponder TAG reader
- Controlled and managed through the bMOTTURA App and the bWEBTECHNOLOGY platform**
- Pairing from master smartphone
- TAG management from master smartphone via bMOTTURA App manageable on time slots for access control system integrated into the lock
- Finishes: black, satin chrome
- Battery and mains powered
- BLE (Bluetooth Low Energy) vers.5 integrated
- Available in version surface mount or built-in

** Function available with bBRIDGE device

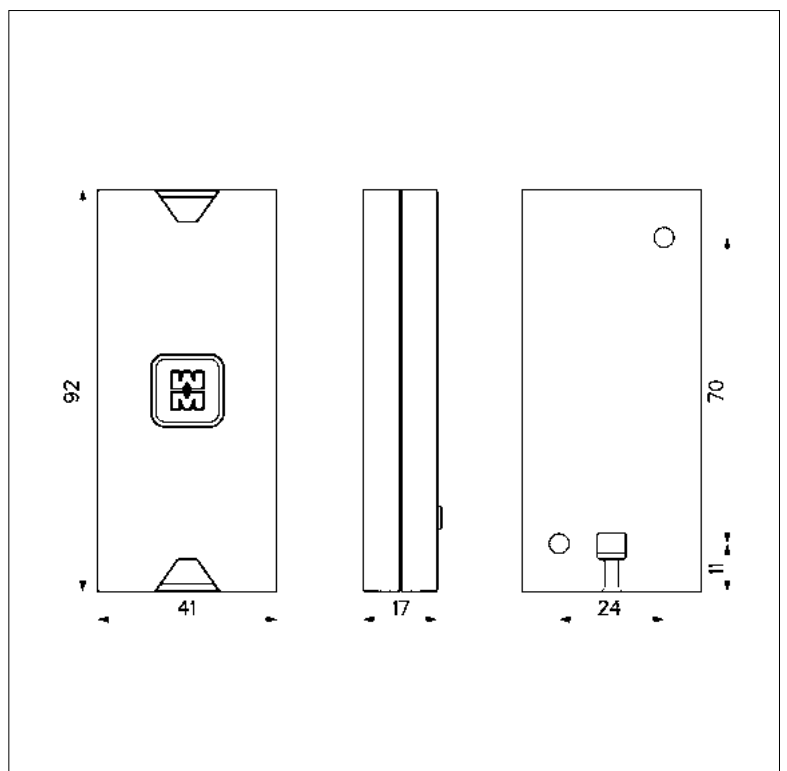

Compatible with Web App and smartphone



bKEY is a Bluetooth remote control, with or without a key inside, that is paired, controlled, and managed via the bMOTTURA App and the bWEBTECHNOLOGY Web App.





Specifications

- Keyfob with or without key inside
- Controlled and managed through the bMOTTURA App and the bWEBTECHNOLOGY platform**
- bKEY manageable on time slots for access control system integrated to the lock
- Pairing from master smartphones
- Battery power supply
- BLE (Bluetooth Low Energy) 5 integrated
- Can be associated with up to 10 devices

** Function available with bBRIDGE device version with internal mechanical safety key

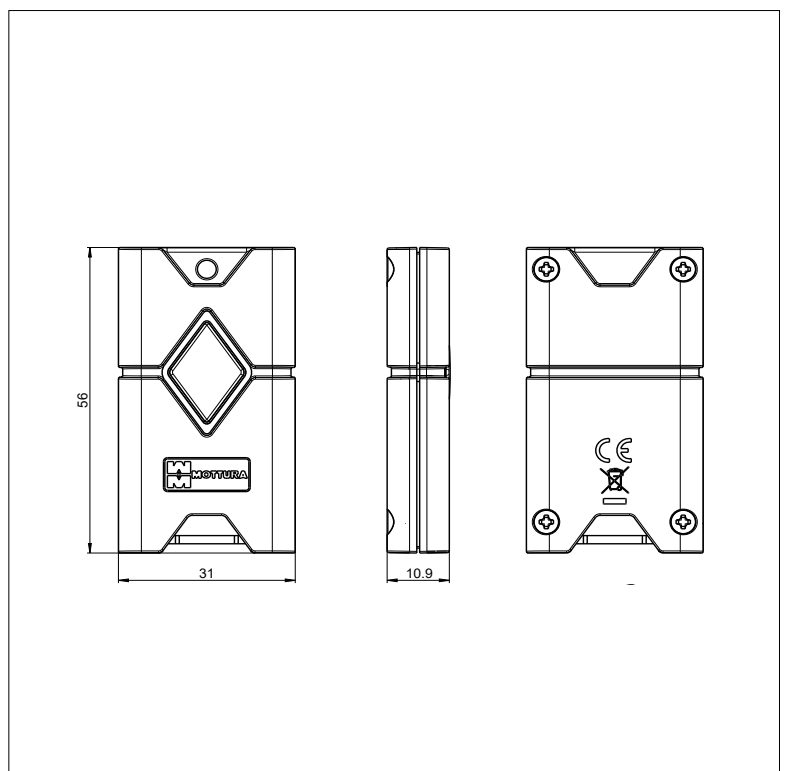

Compatible with Web App and smartphone

b BRIDGE

Thanks to the integrated Bluetooth and Wi-Fi connections, bBRIDGE, connects all the devices in the range via the Internet allowing you to control them from anywhere.





Specifications

- Bridge that allows you to connect the system to the cloud and manage it remotely, accessing all the lock/knob data (data log, diagnostics, anti-burglary, remote opening-closing)
- Connection to intercom cables and other extra access points for their management and opening
- Controlled and managed by the bMOTTURA App system and bTECHNOLOGY
- Power supply via USB-C cable
- BLE (Bluetooth Low Energy) vers.5 integrated
- Pairing from master smartphone
- Integrated Wifi

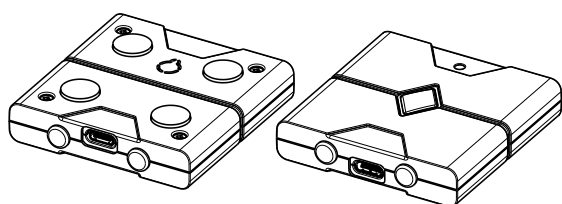

USB-C socket for power supply

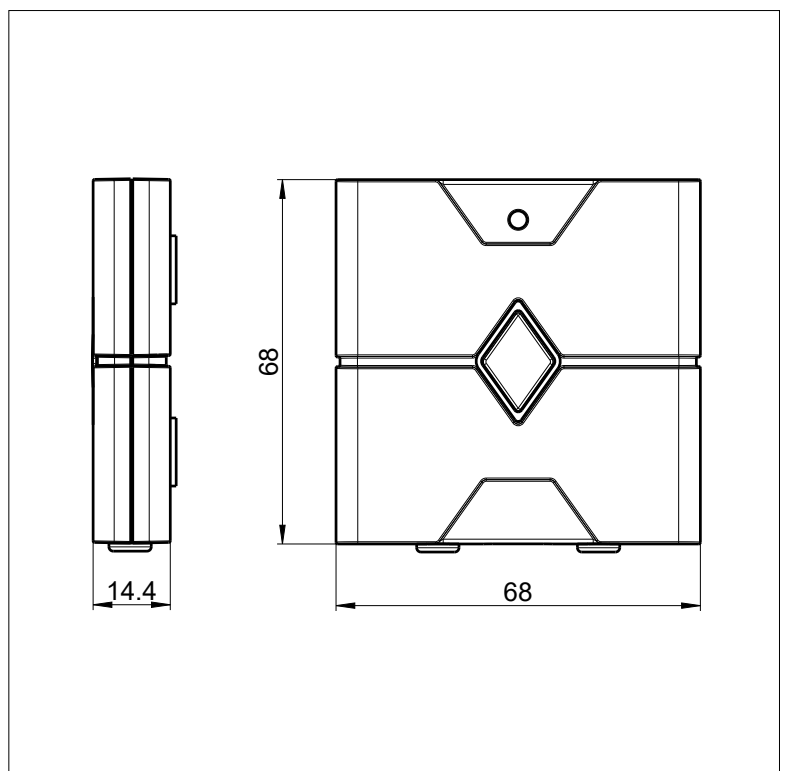

Compatible with Web App and smartphone

App based management both in proximity and remotely

With bMOTTURA you can manage doors, gates and garages from your smartphone easily and securely. Your key becomes digital: smart access, personalized codes, temporary invitations, time-based permissions and real-time notifications ensure precise and flexible access management, tailored to every user's needs.



App based management both in proximity and remotely

Manage all your access points from the palm of your hand. With a single account, you can control all your Mottura smart devices — from locks to accessories.

For remote connectivity, the bBRIDGE must be installed: the device that enables remote control of all products in the bTECHNOLOGY range.

It allows you to organise and monitor every entrance with complete flexibility, adapting to your needs.

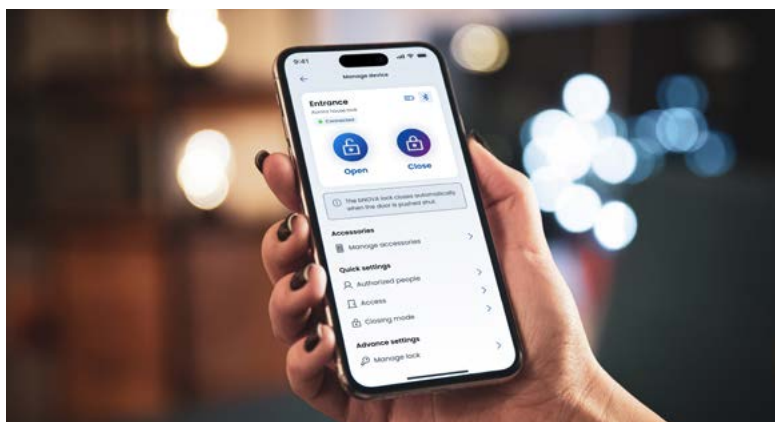

**Easy, personalised
access control,
wherever you are.**

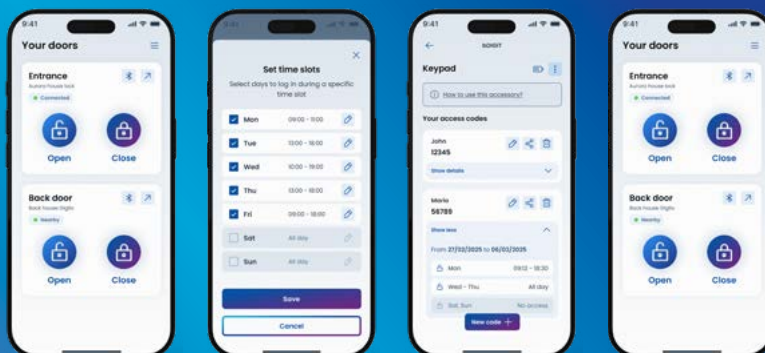

b MOTTURA
App mobile



b WEBTECHNOLOGY
Web app

Specifications

- Opening and closing directly from a smartphone
- Proximity control via Bluetooth
- Remote management via cloud using bBRIDGE
- Creation and sharing of digital keys
- Generation of temporary access
- Management of fingerprints, tags and remote controls associated with the devices
- Configuration of time slots and access permissions
- Display of lock status and connected devices
- Event log and access history consultation
- Integrated diagnostics to monitor correct system operation
- Simple management of multiple access points from a single application

Specifications

- Web access for convenient management also from a PC
- Remote management of locks, users and permissions
- Centralised cloud based supervision of all access points
- Control of multiple entrances and installations from a single platform
- Creation and organisation of authorised users
- Assignment of temporary or scheduled access rights
- Configuration of usage time slots
- Consultation of the event history
- Monitoring of the status of connected devices

Total control, wherever you are

Manage every access point in your home from the palm of your hand. With a single account, you can control all your Mottura smart devices — from locks to accessories.

For remote connectivity, bBRIDGE must be installed: the device that enables remote control of all products in the Mottura bTECHNOLOGY range.

Mottura security and reliability

bMOTTURA is built on more than 50 years of Mottura expertise in the security sector. Smart technology integrates with the highest levels of protection to offer you an advanced, intuitive and secure management experience. Security evolves, and your life becomes simpler.

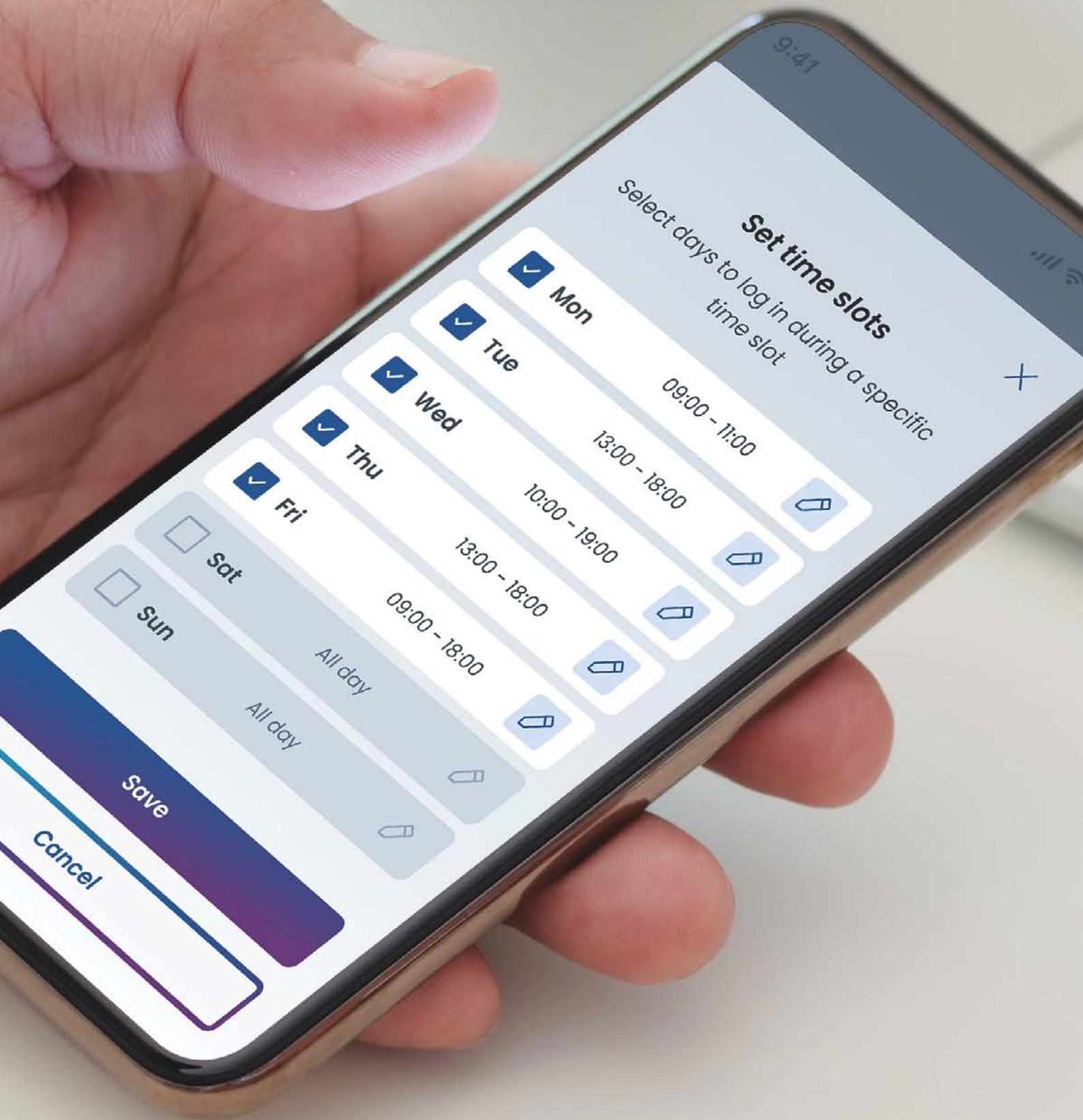

9:41

Set time slots

Select days to log in during a specific time slot



Mon

09:00 - 11:00



Tue

13:00 - 18:00



Wed

10:00 - 19:00



Thu

13:00 - 18:00



Fri

09:00 - 18:00



Sat

All day



Sun

All day

Save

Cancel

MOTTURA TECHNOLOGY®

P190600 ENG - 4/2026



COMPANY WITH
MANAGEMENT SYSTEM
CERTIFIED BY DNV
ISO 9001 • ISO 14001
ISO 45001

Mottura Serrature di Sicurezza SpA

Strada Antica di Francia, 34
10057 Sant'Ambrogio di Torino (TO) - Italia

Part of ASSA ABLOY



   [mottura.it](https://www.mottura.it)